

Doors
Datasheet



Doors of Alara-Lukagro

Why choose Alara-Lukagro? We offer you assurance.

Assurance that you have chosen the best interior and / or exterior door(s) for your project.

- **Certified**

Alara-Lukagro is a pioneer in certified interior and exterior doors. Not only the most diverse combinations but also the most ambitious properties have been tested and certified.

- **Tailor-made**

Alara-Lukagro has high-quality engineering capacities and advanced production methods. This provides us the opportunity to manufacture highly specific requirements and custom-made projects. Providing high quality is self-evident to us.

- **Hassle-free**

Alara-Lukagro is a compact, committed and flexible organisation. This enables us to quickly adapt. We take care of engineering, manufacturing, delivering, installing and maintaining the doors. You can rest assured that you are in good hands with us, whether you require standard doors or your project is more complex.

Combine properties in a single door

Create a safe and comfortable building or space by combining different properties:



Sound insulation



Fire-resistant



Burglary resistance



Anti-panic



Access control

Material

Double-walled door panels with a thickness of 80 mm made of electrolytic galvanized steel plates of different thicknesses, provided with vibration isolation and isolation material, filled with high-quality absorption. Aluminium or stainless steel also possible.

Our doors can be made in standard dimensions as well as custom made.

Airborne noise insulation

Sound reduction index per octave band frequency per door type.

	63	125	250	500	1k	2k	4k	8k	Hz	R _w (C, C _{tr})
AL-D/D45	19	32	41	40	42	49	51	-	dB	45 (-2, -4)
AL-D/D50	11	36	43	47	51	51	52	46	dB	50 (-1, -4)
AL-D/D52	17	36	46	49	52	54	58	52	dB	52 (-1, -4)
AL-D/D54	21	41	48	52	55	55	60	53	dB	54 (0, -3)
AL-D/D56	29	43	49	52	56	59	63	53	dB	56 (-1, -4)
AL-D/D56-H	34	45	48	52	55	55	57	-	dB	54 (0, -2)

Sound reduction index per specific standardized sound spectrum per door type

	R _A house	R _A cinema	R _A pop	R _A ultra bass	R _A dance	R _A back-ground music	R _A road	R _A rail	R _A air traffic	R _A industry
AL-D/D45	31	36	40	24	36	42	35	44	43	37
AL-D/D50	24	33	38	17	31	43	46	50	48	31
AL-D/D52	29	37	42	23	36	47	47	52	50	36
AL-D/D54	34	42	46	27	41	51	51	54	53	41
AL-D/D56	41	46	50	34	46	54	52	56	54	47
AL-D/D56-H	45	47	51	39	49	53	53	54	53	50

Fire-resistance

Fire resistance classification with max. dimensions.

Dimensions are opening sizes in mm zijn springmaten in mm using a corner frame*

Dimensions are opening sizes in mm zijn springmaten in mm using a block frame*









Classification	Single leafed			Double leafed		
	W [m]	H [m]	S [m ²]	W [m]	H [m]	S [m ²]
Ew 30	1,431	3,345	4,00	3,188	3,615	9,62
Ew 60	1,431	3,345	4,00	3,188	3,615	9,62
Ew 90	1,431	3,345	4,00	3,188	3,615	9,62
Ew 120	-	-	-	3,061	3,471	9,25
EI ₂ 30	1,431	3,345	4,00	3,188	3,615	9,62
EI ₂ 60	1,431	3,345	4,00	3,061	3,471	9,25
EI ₂ 90	1,158	2,685	3,11	-	-	-
EI ₁ 30	1,431	3,345	4,00	3,188	3,615	9,62
EI ₁ 60	1,431	3,345	4,00	3,061	3,471	9,25
EI ₁ 90	-	-	-	-	-	-

Classification	Single leafed			Double leafed		
	W [m]	H [m]	S [m ²]	W [m]	H [m]	S [m ²]
Ew 30	1,395	3,327	3,87	3,152	3,597	9,45
Ew 60	1,395	3,327	3,87	3,152	3,597	9,45
Ew 90	1,395	3,327	3,87	3,152	3,597	9,45
Ew 120	-	-	-	3,025	3,453	9,08
EI ₂ 30	1,395	3,327	3,87	3,152	3,597	9,45
EI ₂ 60	1,395	3,327	3,87	3,025	3,453	9,08
EI ₂ 90	1,122	2,667	2,99	-	-	-
EI ₁ 30	1,395	3,327	3,87	3,152	3,597	9,45
EI ₁ 60	1,395	3,327	3,87	3,025	3,453	9,08
EI ₁ 90	-	-	-	-	-	-

W = Width / H = Height / S = Surface

*As restriction the height and width are applied as maximum acceptable dimensions. The described dimension for the surface cannot be exceeded.

Performances doors of Alara-Lukagro

FUNCTION		SYMBOL	APPLICATION	STANDARDS	PERFORMANCES ALARA-LUKAGRO (MAX.)
FIRE-RESISTANCE		EW Ei1 Ei2	Netherlands Belgium Europe	EN 1634-1	EW 120 Ei1 90 Ei2 90
BURGLARY-RESISTANCE		WK	Europe	EN 1627 EN 1628 EN 1629 EN 1630	WK3
SOUND-INSULATION		A	Europe	EN ISO 1403 EN ISO 717-1	Rw 56dB Ra house 45 Ra bios 47 Ra pop 51 Ra weg 53 Ra rail 56 Ra industrie 50 Ra dance 49
AIRTIGHTNESS		L	Europe	EN 12207 EN 1026	L4
WATER-TIGHTNESS		E	Europe	EN 12208 EN 1027	7A
WINDPROOF		V	Europe	EN 12210 EN 12211	V3C
THERMAL INSULATING		T	Europe	EN 10077-1 EN 10077-2 EN 12567-1	0.9 - 1.4 W/m²K
ANTI-PANIC			Europe	EN 1125 EN 179	EN 1125 EN 179
USER-FREQUENCY		F	Europe	EN 1191 EN 14600 EN 12400	F6

Options

Our doors are offered with a variety in options.

Hinges and locks

Very wide range of door hinges and locks, such as door fittings, locks, hinges, panic bars and door closers. Mechanical as well as electrical options possible.

Glass

Sound insulating glass in several dimensions.

Block- or Corner frame

Block frame with integrated adjusting mechanism, manufactured from 2 mm galvanized steel plates, which can be mounted directly to a perpendicular stable clear wall opening.

Threshold

Standaard: raised threshold with single sealing. All doors can be combined with alternative thresholds, like drop seals, low thresholds, etc.

Sealing

To guarantee an optimal acoustic sealing, each door leaf and frame is fitted with exclusively designed profiled rubber seals:

- AL-D/D45: profiled rubber on doorleaf.
- AL-D/D50 - 56: profiled rubber on frame and on doorleaf.

Coating & covering

Powder coating or wet-paint composition in RAL- and NCS-colours, supply under certification (e.g. with coating-thickness measurements). Possible with wood finish or photo print - applied by third parties.

Additional accessories

The door can be enhanced by including various additional accessories such as storm door chains, pole contactors, solenoids and such.

Please visit our website for a detailed description of our assortment.



Drawings Alara-Lukagro Doors

Standard drawings AL-D/D45

Door thickness of 80 mm.

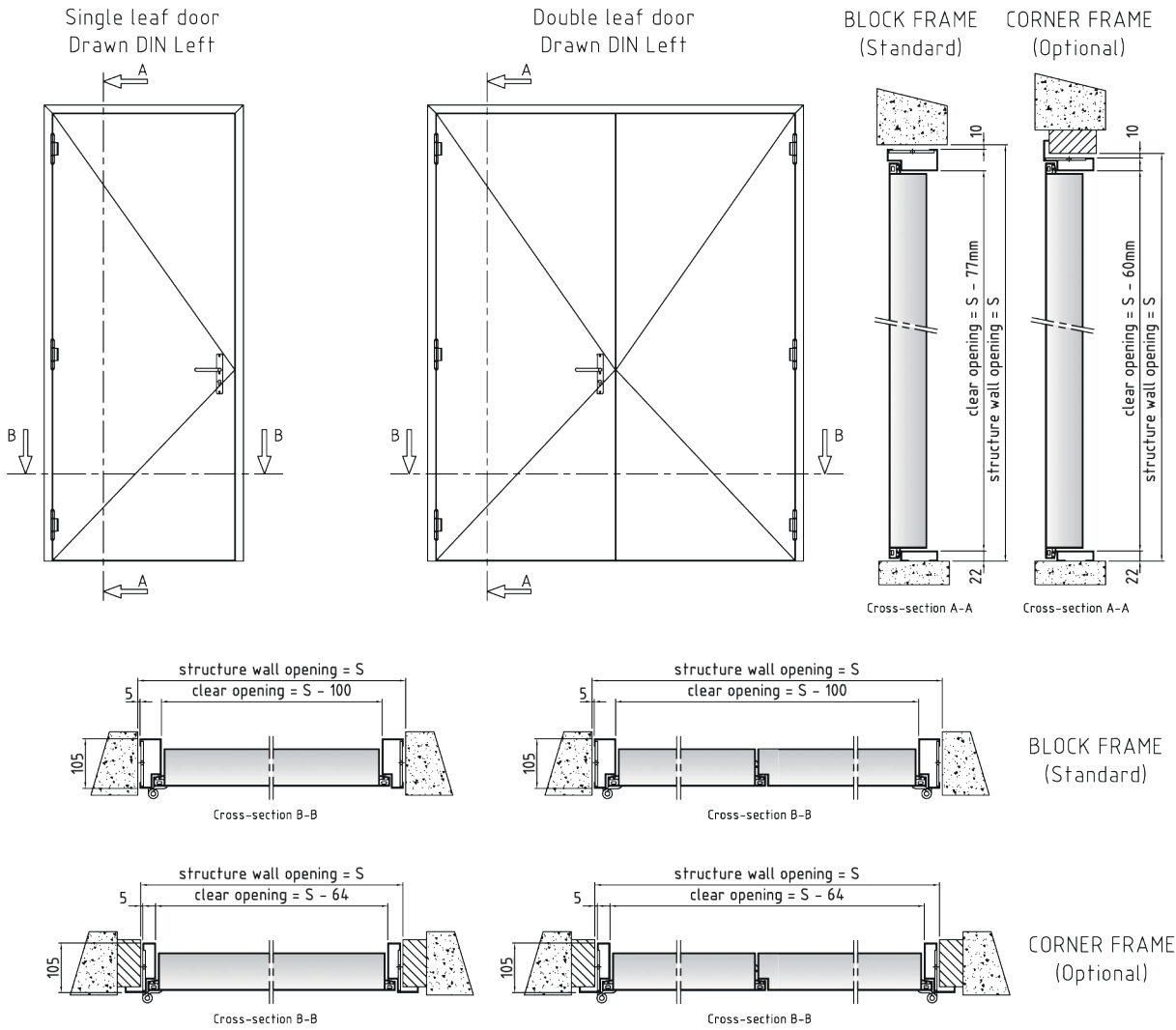

Thresholds AL-D/D45

Door thickness of 80 mm.

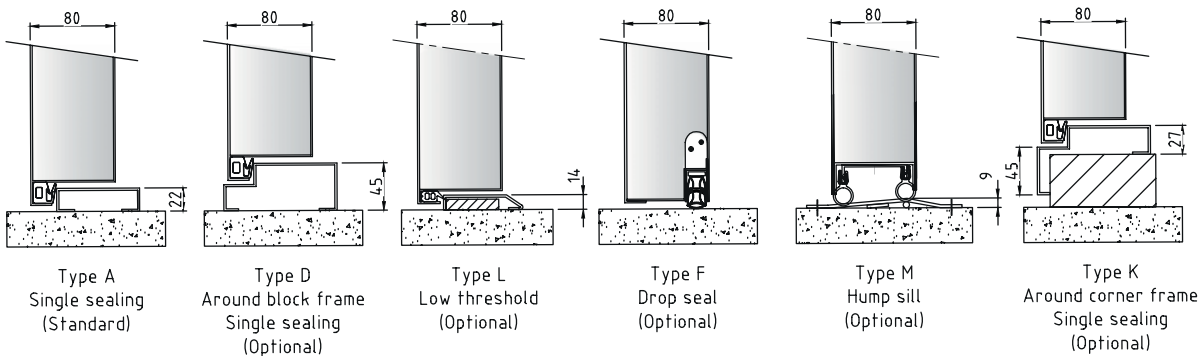

Drawings Alara-Lukagro Doors

Construction to wall AL-D/D45

BLOCK FRAME
(Standard)

CORNER FRAME
(Optional)

Concrete wall opening

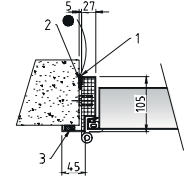
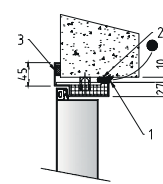
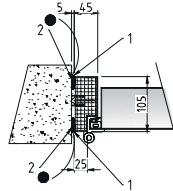
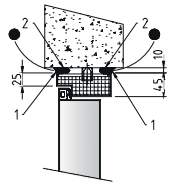

Hardwood wall opening

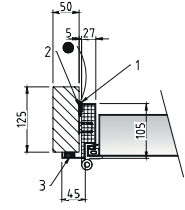
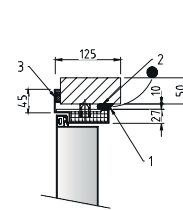
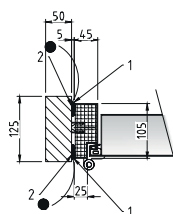
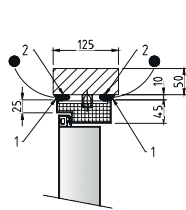

MS100+
Tube 100x100x5
wall opening

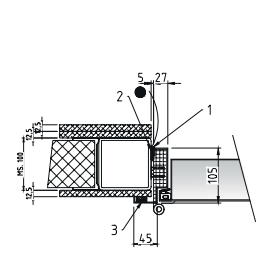
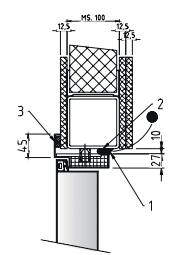
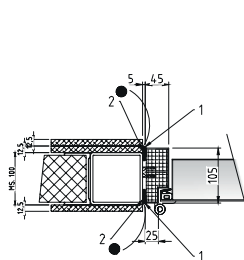
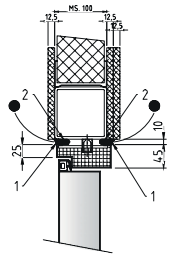

Hollow brick wall opening

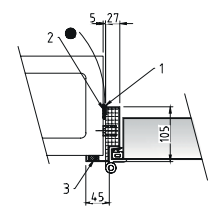
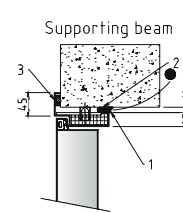
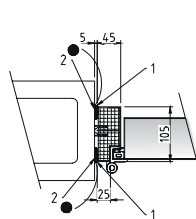
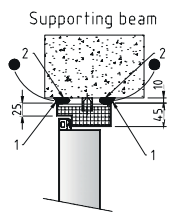

Steel beam UNP
wall opening

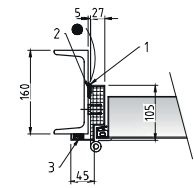
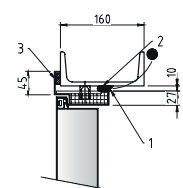
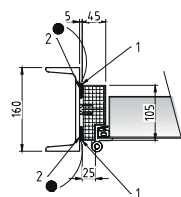
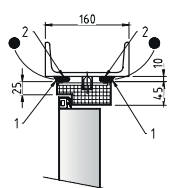

- Legend: 1 Kit
2 Backing foam
3 Swell tape

Wall opening constructed by third party

Drawings Alara-Lukagro Doors

Standard drawings AL-D/D50 - D56

Door thickness of 80 mm.

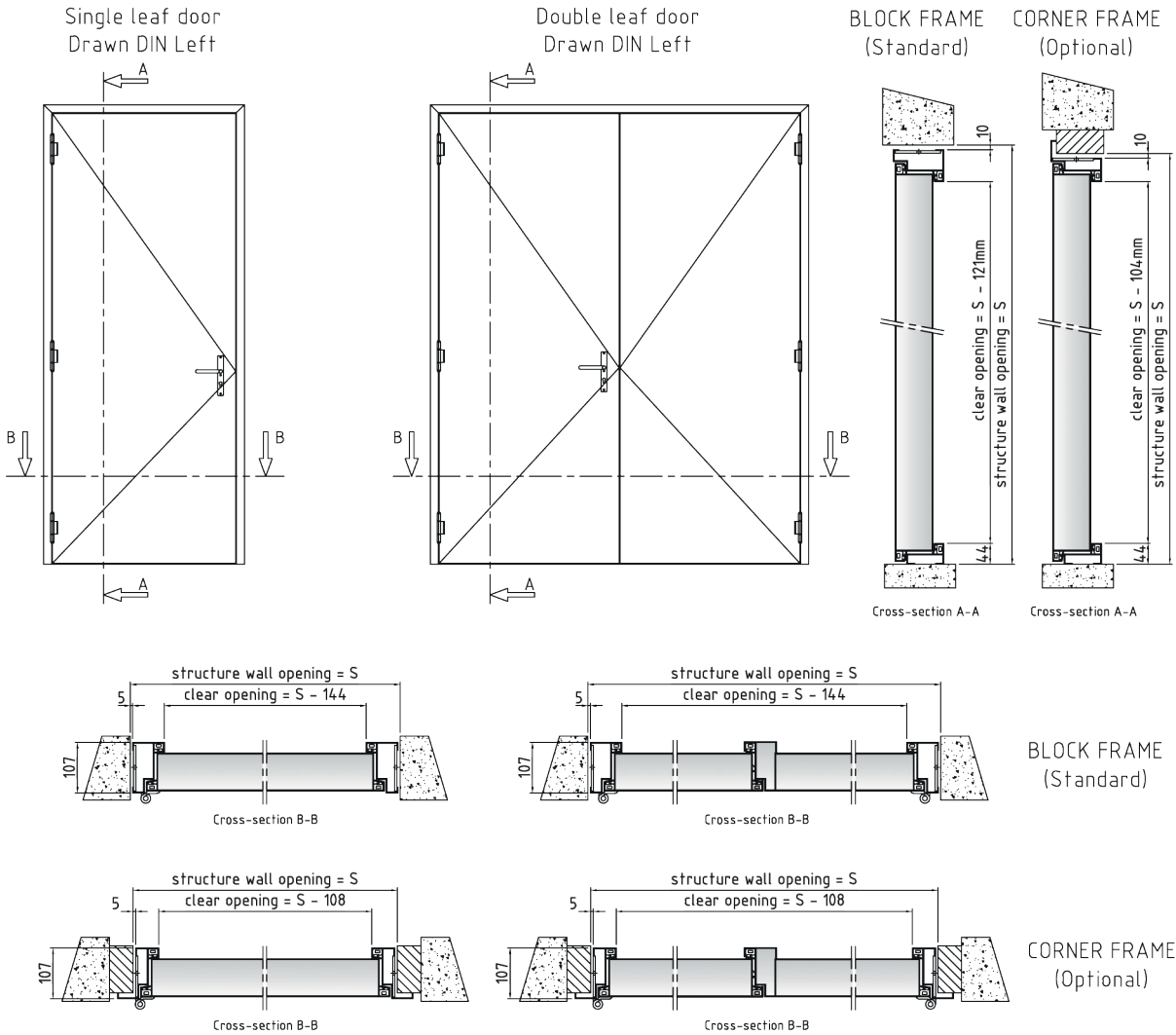

Thresholds AL-D/D50 - D56

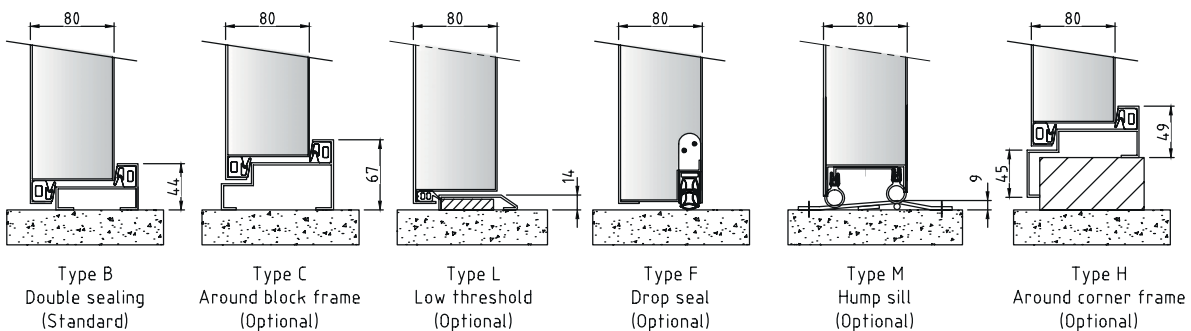

Drawings Alara-Lukagro Doors

Construction to wall AL-D/D50 - D56

Door thickness of 80 mm.

BLOCK FRAME
(Standard)

CORNER FRAME
(Optional)

Concrete
wall opening

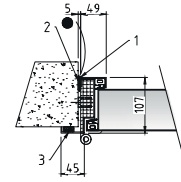
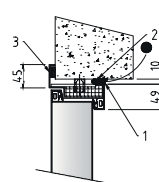
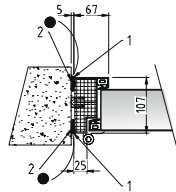
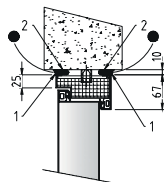

Hardwood
wall opening

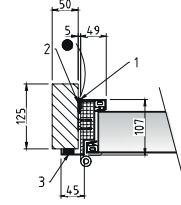
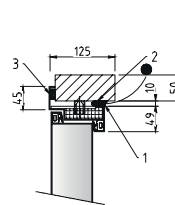
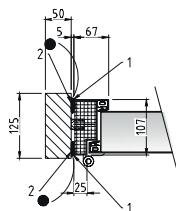
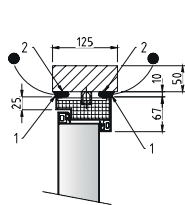

MS100+
Tube 100x100x5
wall opening

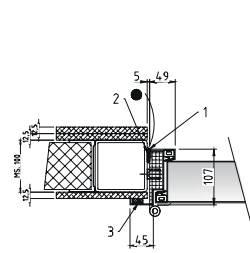
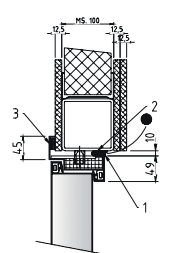
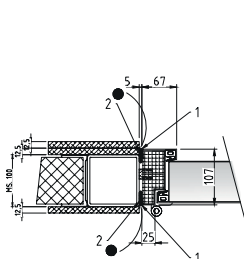
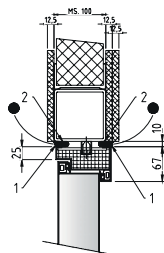

Hollow brick
wall opening

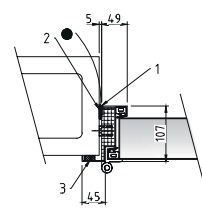
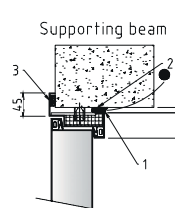
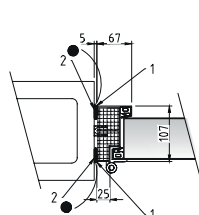
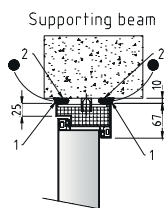

Steel beam UNP
wall opening

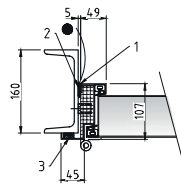
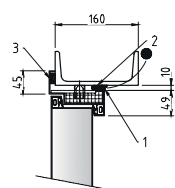
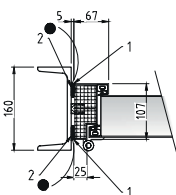
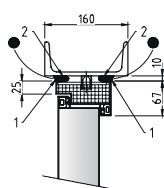

- Legend: 1 Kit
2 Backing foam
3 Swell tape

Wall opening constructed by third party

Drawings Alara-Lukagro Doors

Standard drawings AL-D/D56H

Door thickness of 103 mm.

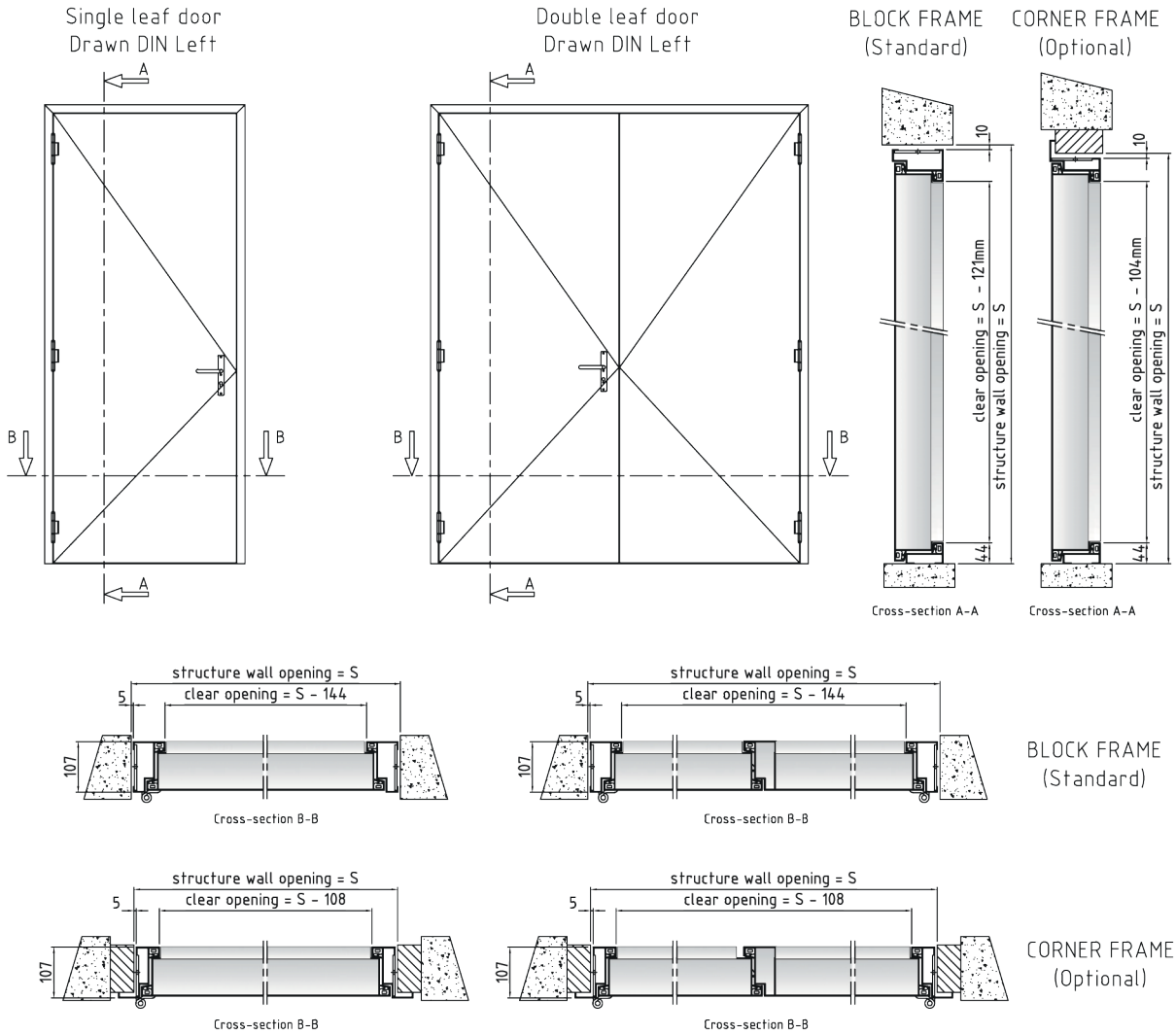

Thresholds AL-D/D56H

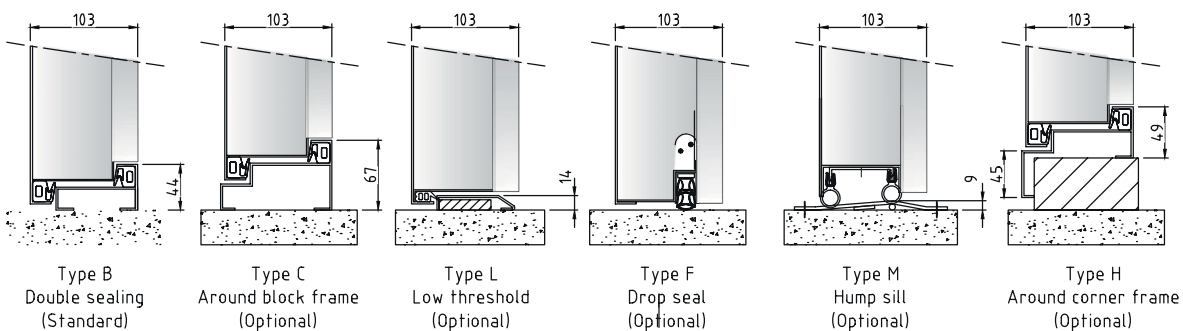

Construction to wall AL-D/D56H

Equal to the details of the AL-D/D50- D56. Keep in mind that the AL-D/D56H doors have a thickness of 103 mm instead of 80 mm.



Door page
www.alara-lukagro.com



Projects doors
www.alara-lukagro.com

Your contact



Ronald van Ditshuizen | Senior Sales Engineer
T direct +31 (0) 184 820 722
E r.van.ditshuizen@alara-lukagro.com

Alara-Lukagro

P.O. Box 15, 2964 ZG Groot-Ammers | Huijgensweg 3, Groot-Ammers | **The Netherlands**
T +31 (0) 184 661 700 | E info@alara-lukagro.com | www.alara-lukagro.com



[linkedin.com/company/alara-lukagro](https://www.linkedin.com/company/alara-lukagro)



facebook.com/AlaraLukagro



twitter.com/AlaraLukagro